



PRODUCT FEATURES

- Single glazed
- Hinged rear door
- Four adjustable shelves
- Ticket strips on shelves and base
- Under shelf and canopy LED lights
- Sliding front doors - optional
- Ambient converted from heated
- Air removal fan installed in ceiling

CABINET DIMENSIONS & SPECIFICATIONS

Ambient

Model	Cabinet			Shelving no.	Shelf length	Base tray w x d	Total food units	Display m ²
	Length mm	Depth mm	Height mm					
BTGAB6	600	750	1380	4 + base	490 x 445	540 x 510	100	1.14

Prior to installation see, installation guidelines, ventilation requirements and drainage options documents

Operating Current	Connection	Voltage
		50/60 Hertz
0.3 Amp	10amp 3 pin plug	240V

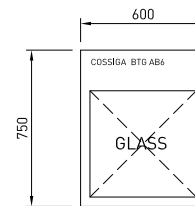

ELECTRICAL POWER

Electrical power cord 2200mm
3 pin 10 amp 1 phase socket required

Maximum shelf load weight 15kg
spread evenly

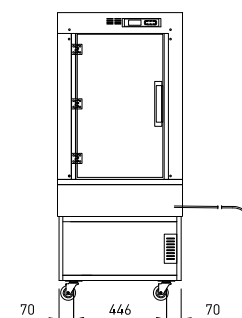
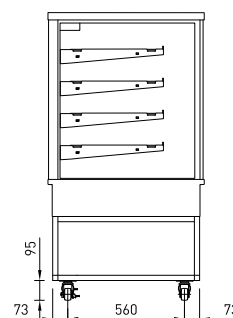
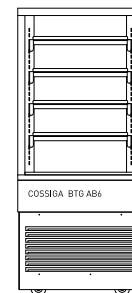
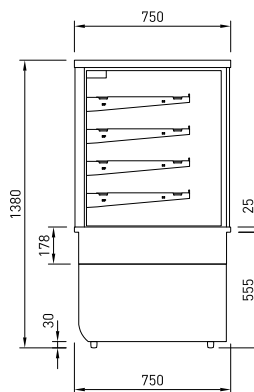

REAR VIEW



PRODUCT FEATURES

- Single glazed
- Sliding rear doors
- Four adjustable shelves
- Ticket strips on shelves and base
- Under shelf and canopy LED lights
- Sliding front doors - optional
- Ambient converted from heated
- Air removal fan installed in ceiling

CABINET DIMENSIONS & SPECIFICATIONS

Ambient

Model	Cabinet			Shelving no.	Shelf length	Base tray w x d	Total food units	Display m ²
	Length mm	Depth mm	Height mm					
BTGAB9	900	750	1380	4 + base	790 x 445	840 x 510	168	1.83

Prior to installation see, installation guidelines, ventilation requirements and drainage options documents

Operating Current	Connection	Voltage
0.3 Amp	10amp 3 pin plug	50/60 Hertz 240V

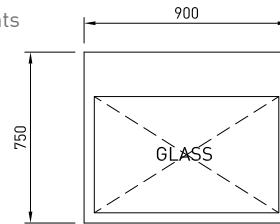

ELECTRICAL POWER

Electrical power cord 2200mm
3 pin 10 amp 1 phase socket required

Maximum shelf load weight 15kg
spread evenly

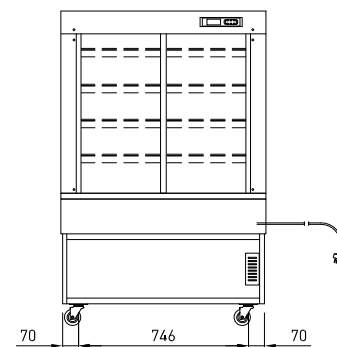
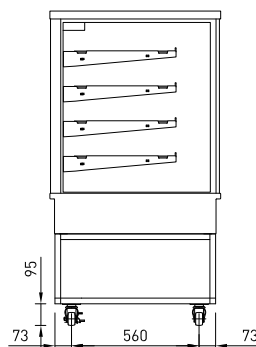
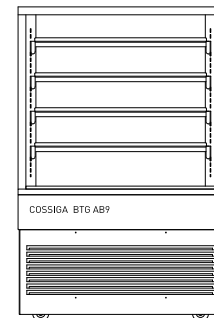
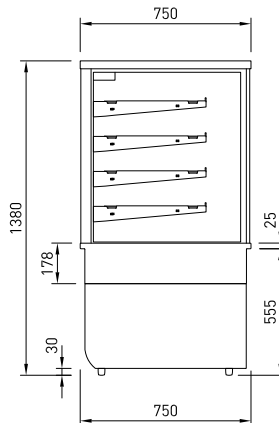

REAR VIEW



PRODUCT FEATURES

- Single glazed
- Sliding rear doors
- Four adjustable shelves
- Ticket strips on shelves and base
- Under shelf and canopy LED lights
- Sliding front doors - optional
- Ambient converted from heated
- Air removal fan installed in ceiling

CABINET DIMENSIONS & SPECIFICATIONS

Ambient

Model	Cabinet			Shelving no.	Shelf length	Base tray w x d	Total food units	Display m2
	Length mm	Depth mm	Height mm					
BTGAB12	1200	750	1380	4 + base	1090 x 445	1140 x 510	100 x 100	255
								2.52

Prior to installation see, installation guidelines, ventilation requirements and drainage options documents

Operating Current	Connection	Voltage
		50/60 Hertz
0.4 Amp	10amp 3 pin plug	240V

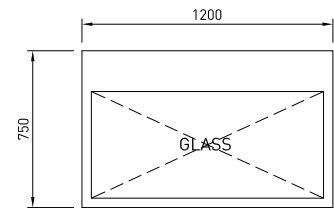

ELECTRICAL POWER

Electrical power cord 2200mm
3 pin 10 amp 1 phase socket required

Maximum shelf load weight 15kg
spread evenly

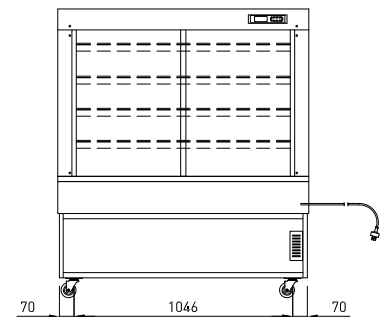
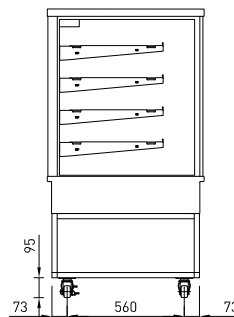
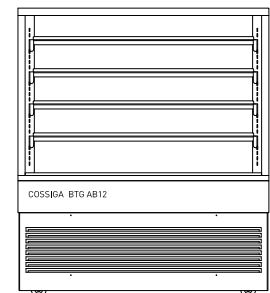
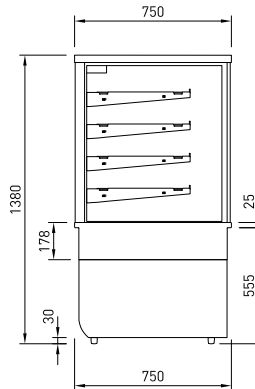

REAR VIEW



PRODUCT FEATURES

- Single glazed
- Sliding rear doors
- Four adjustable shelves
- Ticket strips on shelves and base
- Under shelf and canopy LED lights
- Sliding front doors - optional
- Ambient converted from heated
- Air removal fan installed in ceiling

CABINET DIMENSIONS & SPECIFICATIONS

Ambient

Model	Cabinet			Shelving no.	Shelf length	Base tray w x d	Total food units	Display m2
	Length mm	Depth mm	Height mm					
BTGAB15	1500	750	1380	4 + base	1390 x 445	1440 x 510	100 x 100 355	3.20

Prior to installation see, installation guidelines, ventilation requirements and drainage options documents

Operating Current	Connection	Voltage
0.5 Amp	10amp 3 pin plug	50/60 Hertz 240V

ELECTRICAL POWER

Electrical power cord 2200mm
3 pin 10 amp 1 phase socket required

Maximum shelf load weight 15kg
spread evenly

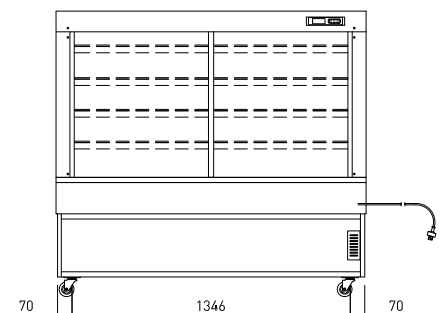
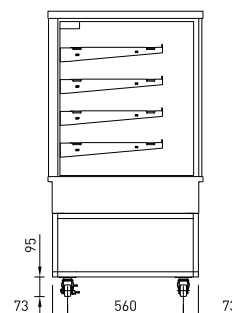
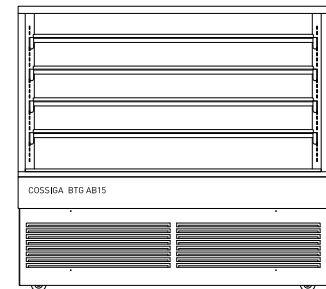
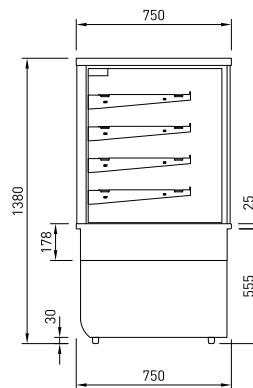
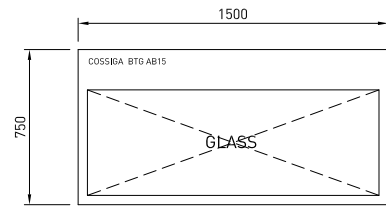

REAR VIEW